



## 6° TEXTILE INNOVATION DAY

“Edifici tessili? Nuove applicazioni e materiali per l’abitare sostenibile”

Biella, 18 aprile 2012

# Med in Italy

Un nuovo concetto di casa mediterranea sostenibile



Chiara Tonelli

Innovation Day\_ 18.04.2012 \_ Chiara Tonelli \_ MED in ITALY – Università Roma TRE



# La competizione







## SOLAR DECATHLON EUROPE 2010

---



## SOLAR DECATHLON 2011

- 
1. Brazil, Universidade Federal de Santa Catarina and Universidade de São Paulo
  2. China, Tongji University
  3. Denmark, Technical University of Denmark
  4. Egypt, American University in Cairo
  5. France, Arts et Métiers Paristech Bordeaux
  6. France, Team Rhône-Alpes, Ensag
  7. Germany, Rwth Aachen University
  8. Germany, University of Applied Sciences Konstanz
  9. Hungary, Budapest University of Technology and Economics
  - 10. Italy, Università degli Studi di Roma Tre and Sapienza Università di Roma**
  11. Japan, Chiba University
  12. Netherlands, Delft University of Technology
  13. Norway, Norwegian University of Science and Technology
  14. Portugal, Universidade do Porto
  15. Romania, “Ion Mincu” University of Architecture and Urbanism, University Polytechnic of Bucharest and Technical University of Civil Engineering of Bucharest
  16. Spain, Universidad Ceu Cardenal Herrera de Valencia
  17. Spain, Universidad de Sevilla, Universidad de Granada, Universidad de Málaga, Universidad de Jaén)
  18. Spain, Universidad del País Vasco, Euskal Herriko Unibertsitatea
  19. Spain, Universitat Politècnica De Catalunya (Upc)
  20. United Kingdom, London Metropolitan University

## SOLAR DECATHLON EUROPE 2012

## Le 10 prove



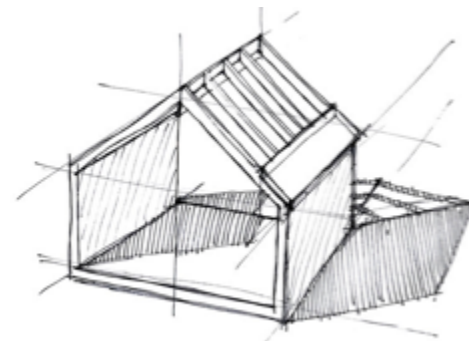
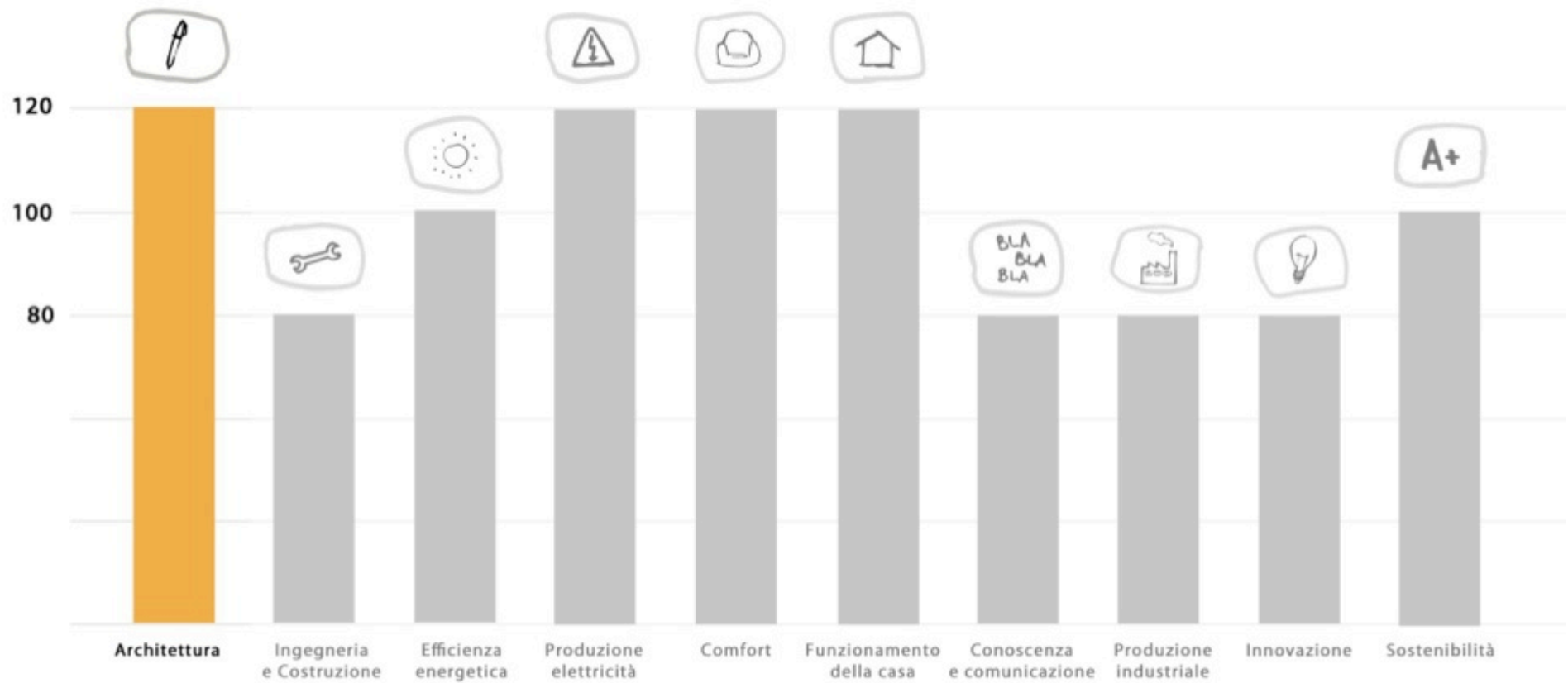

# ARCHITETTURA

Innovation Day\_ 18.04.2012 \_ Chiara Tonelli \_ MED in ITALY – Università Roma TRE



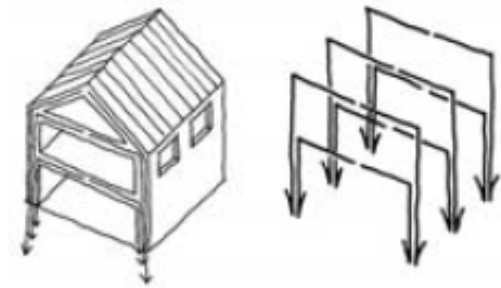
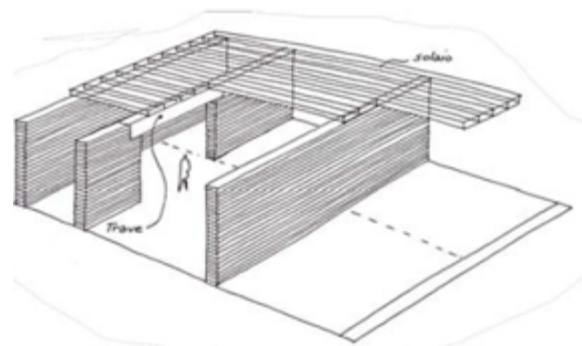
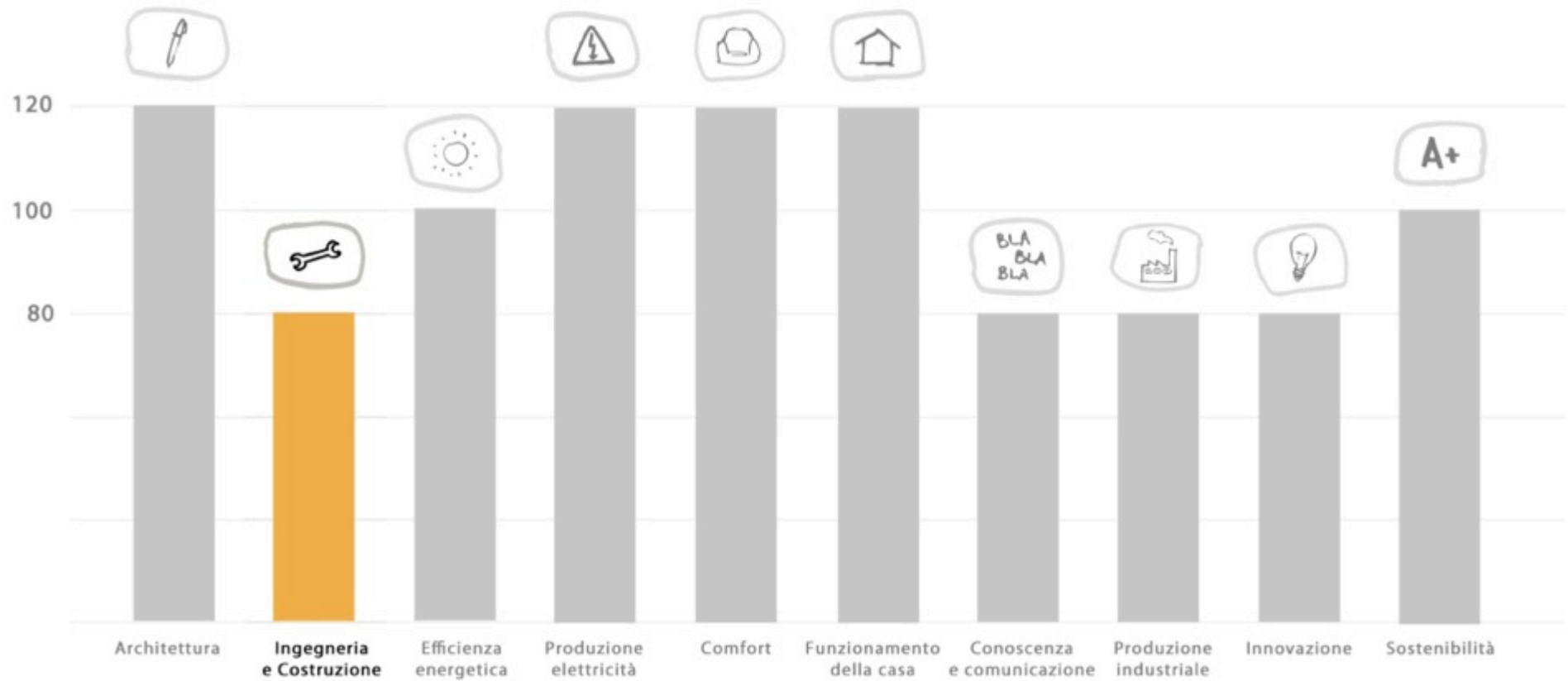

# INGEGNERIA E COSTRUZIONE

Innovation Day\_13.04.2012\_Chiara Tonello\_MED in ITALY - Università Roma TRE

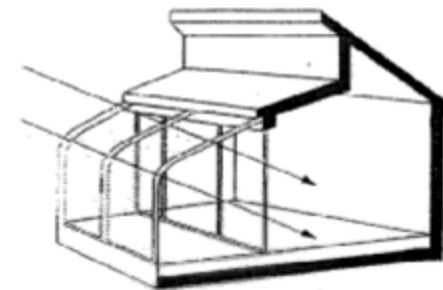
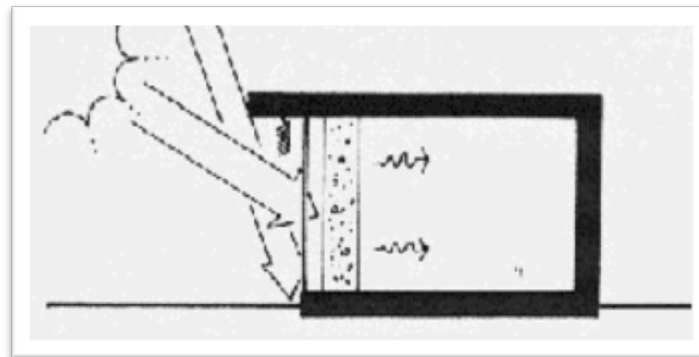
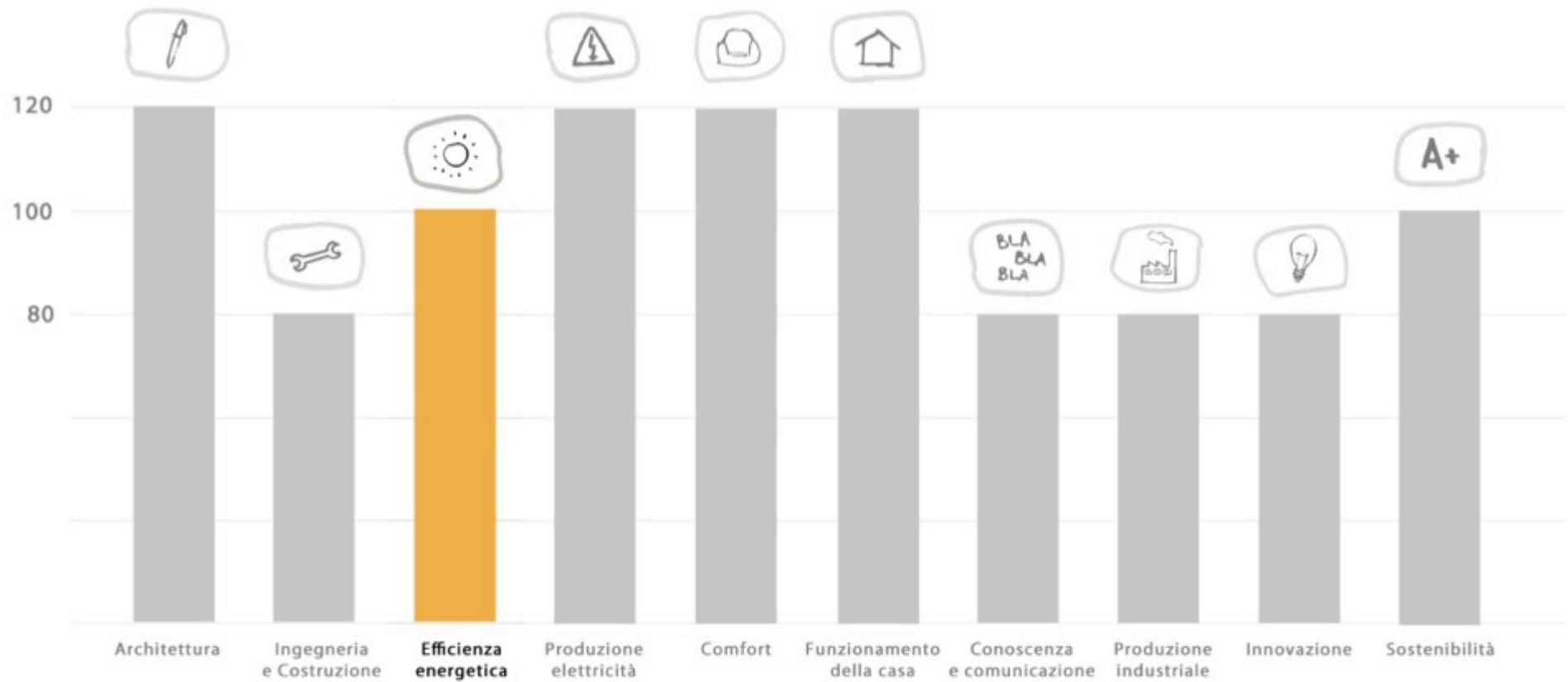

# EFFICIENZA ENERGETICA

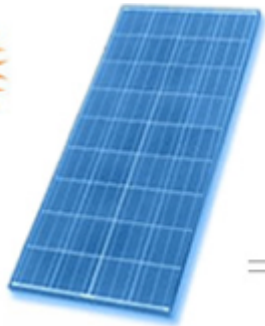
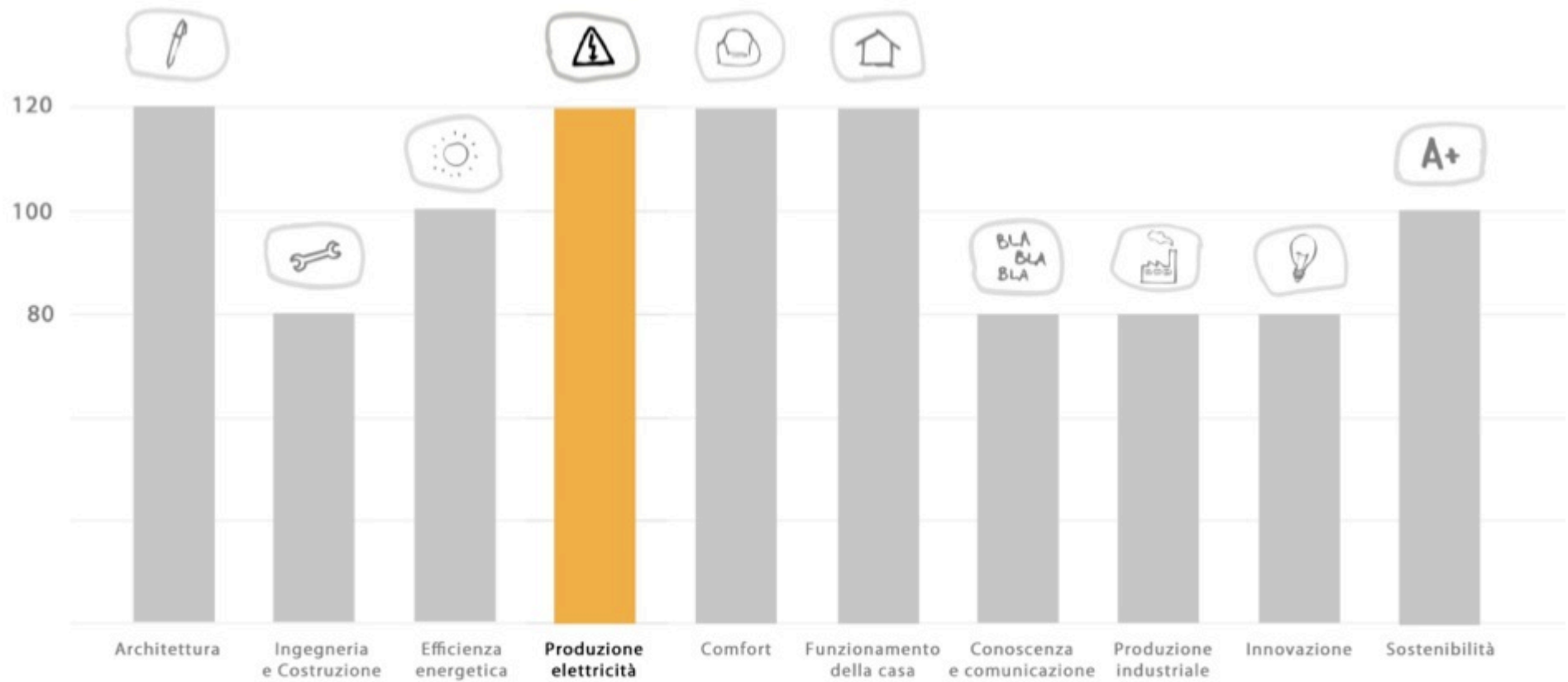

=



# BILANCIO ENERGETICO

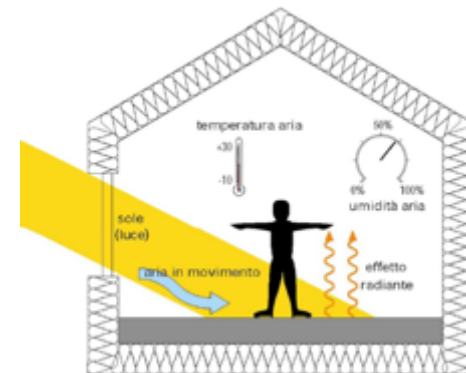
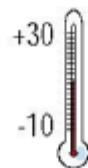
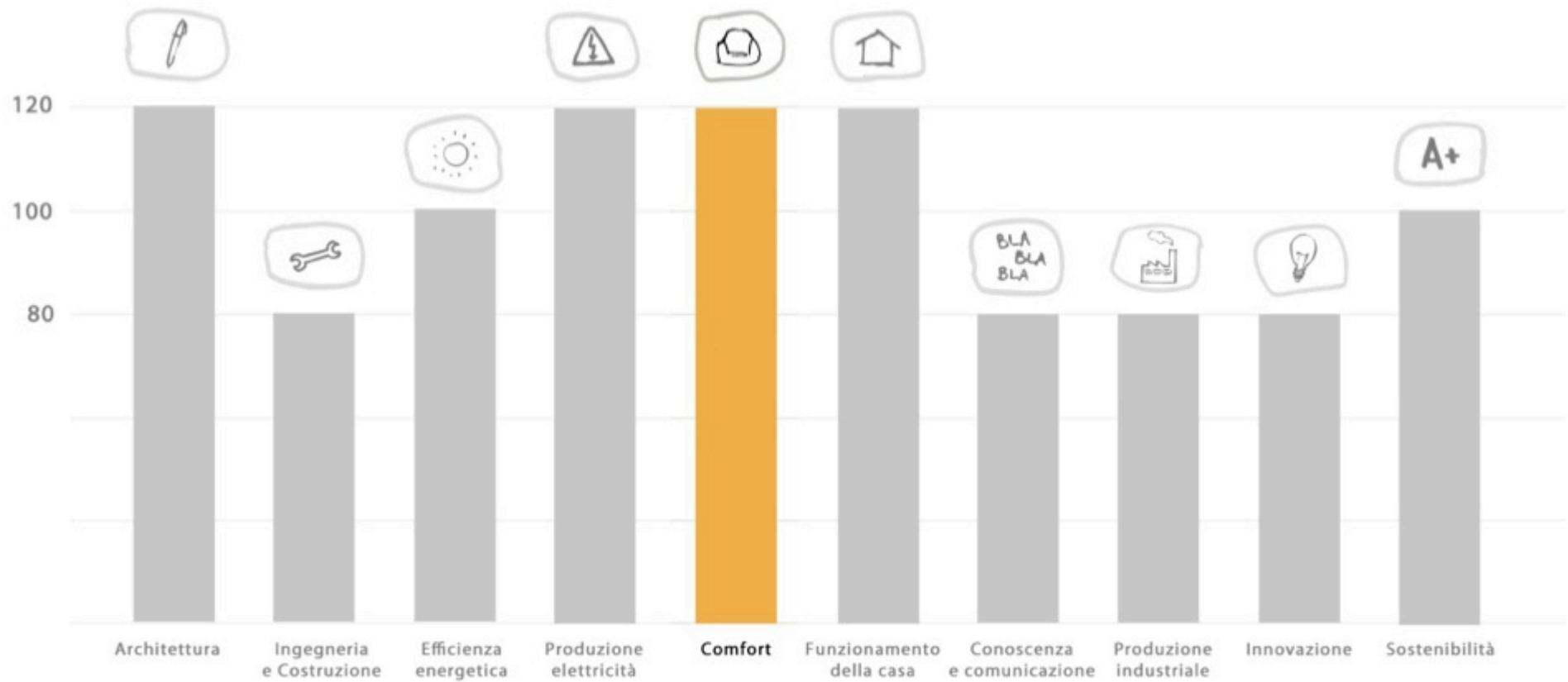

# COMFORT

Innovation Day\_ 16.04.2012 \_ Chiara Tonelli \_ MED in ITALY – Università Roma TRE

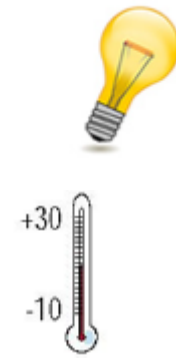
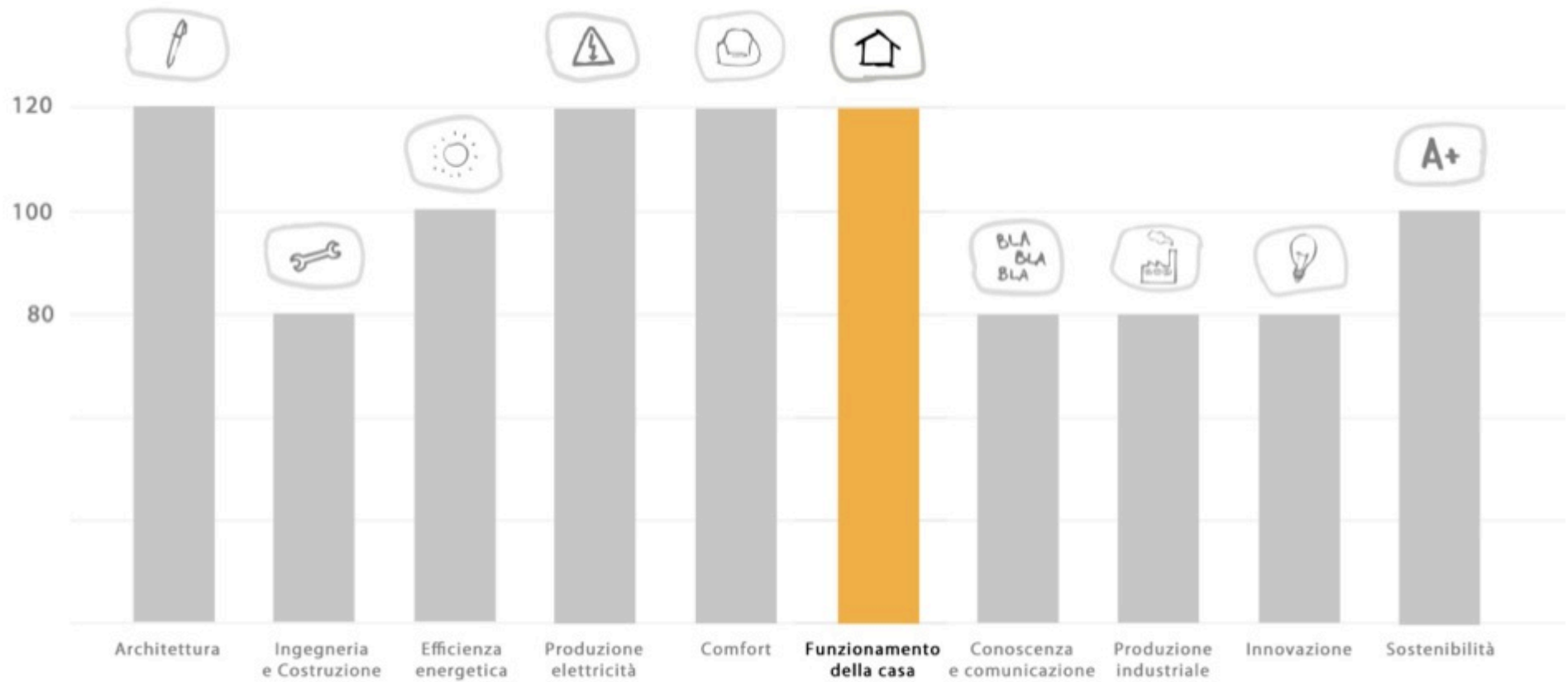

# FUNZIONAMENTO DELLA CASA

Innovation Day \_ 16.04.2012 \_ Chiara Tonelli \_ MED in ITALY - Università Roma TRE

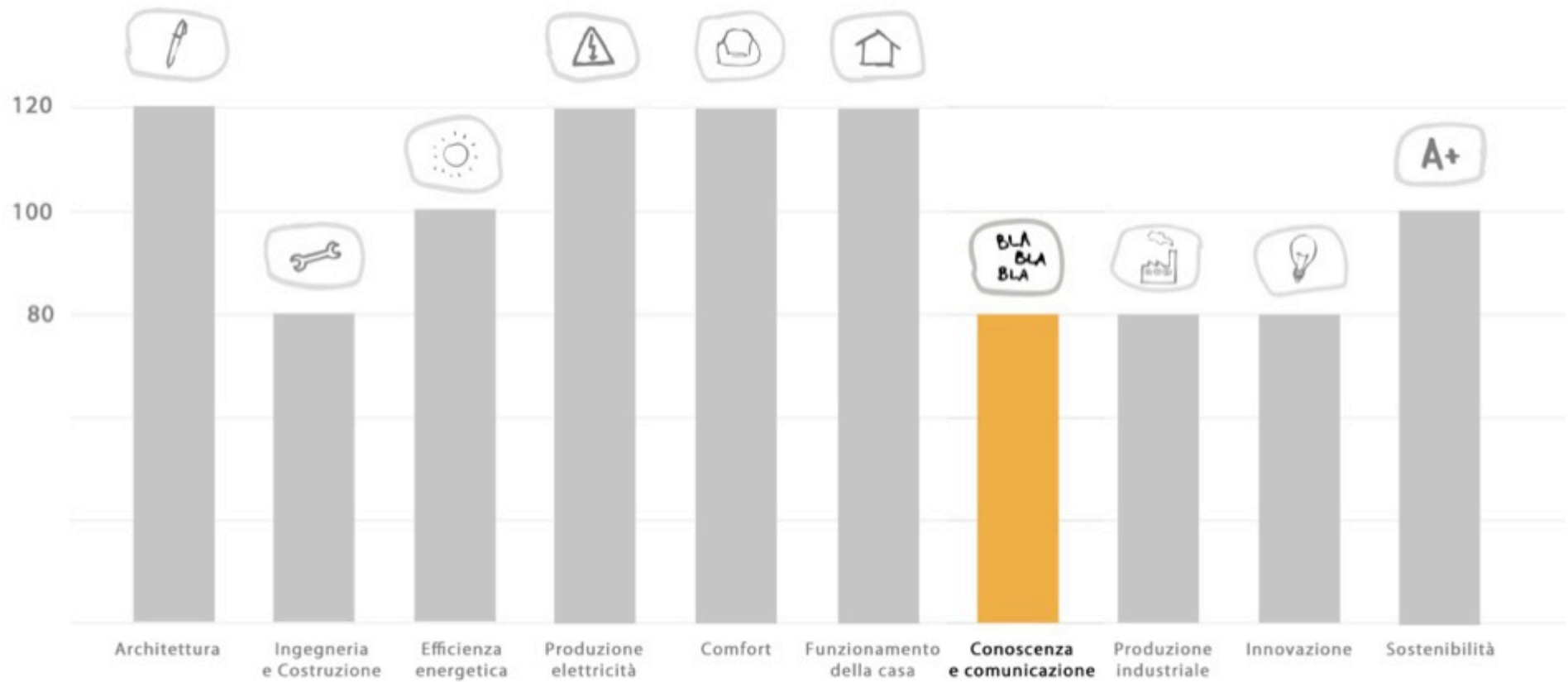

# CONOSCENZA E COMUNICAZIONE

Innovation Day\_ 16.04.2012\_ Chiara Tonello\_ MED in ITALY - Università Roma TRE

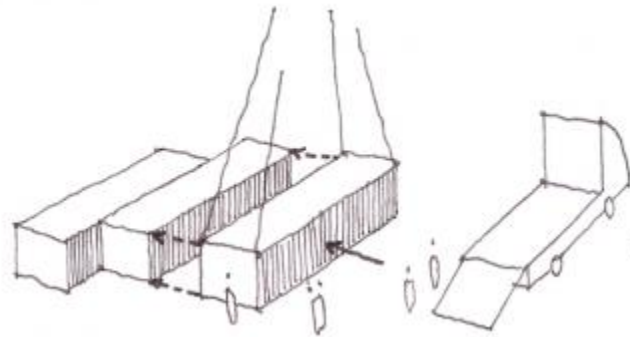
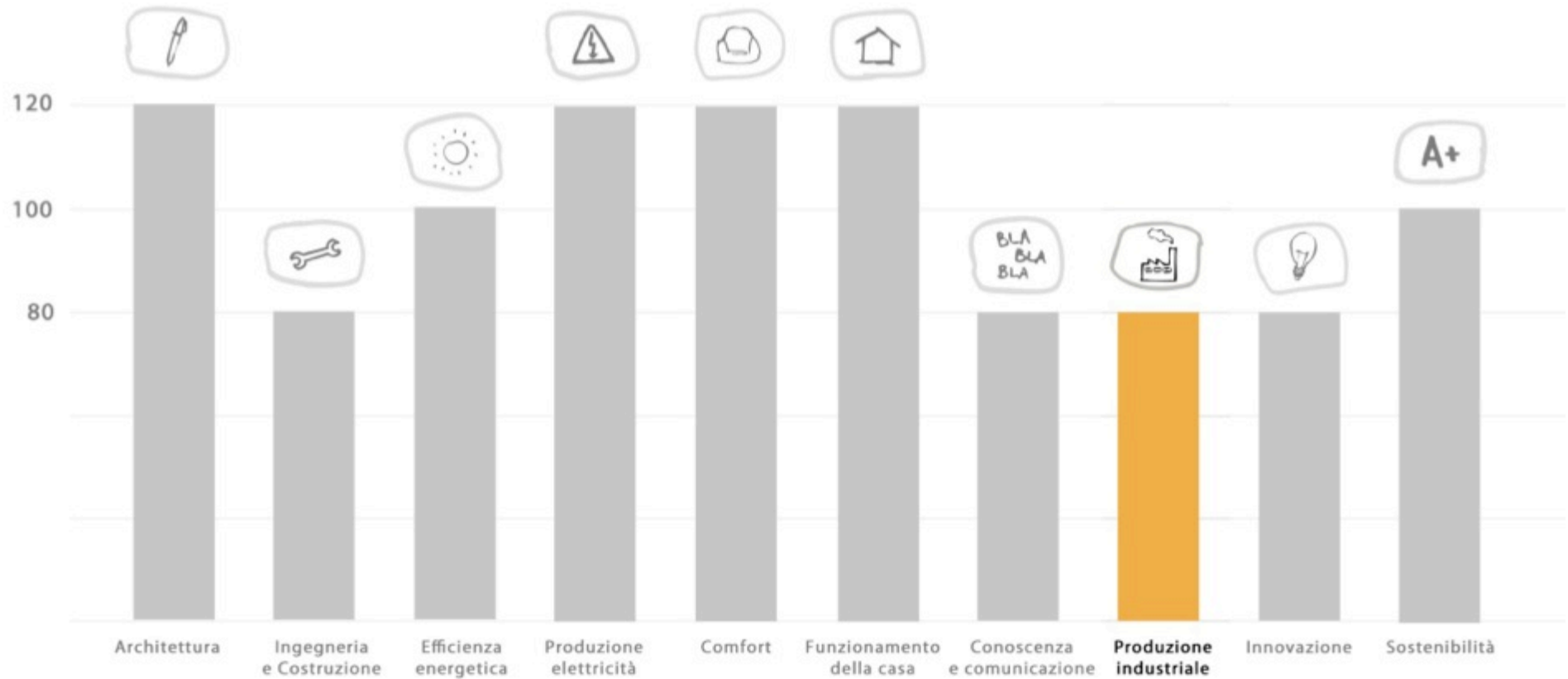

# PRODUZIONE INDUSTRIALE

Innovation Day\_ 18.04.2012\_ Chiara Tonelli\_ MED in ITALY - Università roma TRE

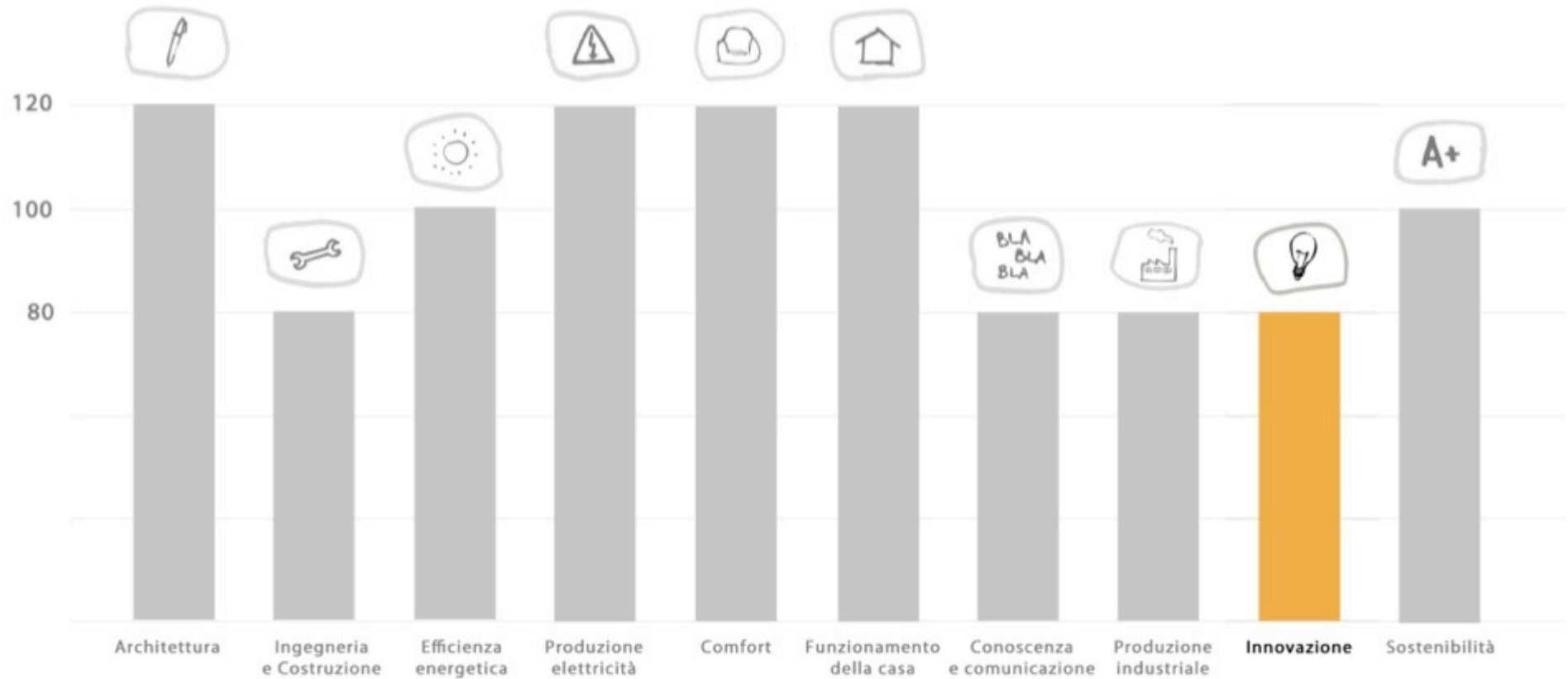

# INNOVAZIONE

Innovation Day\_18.04.2012\_ Chiara Tonelli \_ MED in ITALY – Università Roma TRE



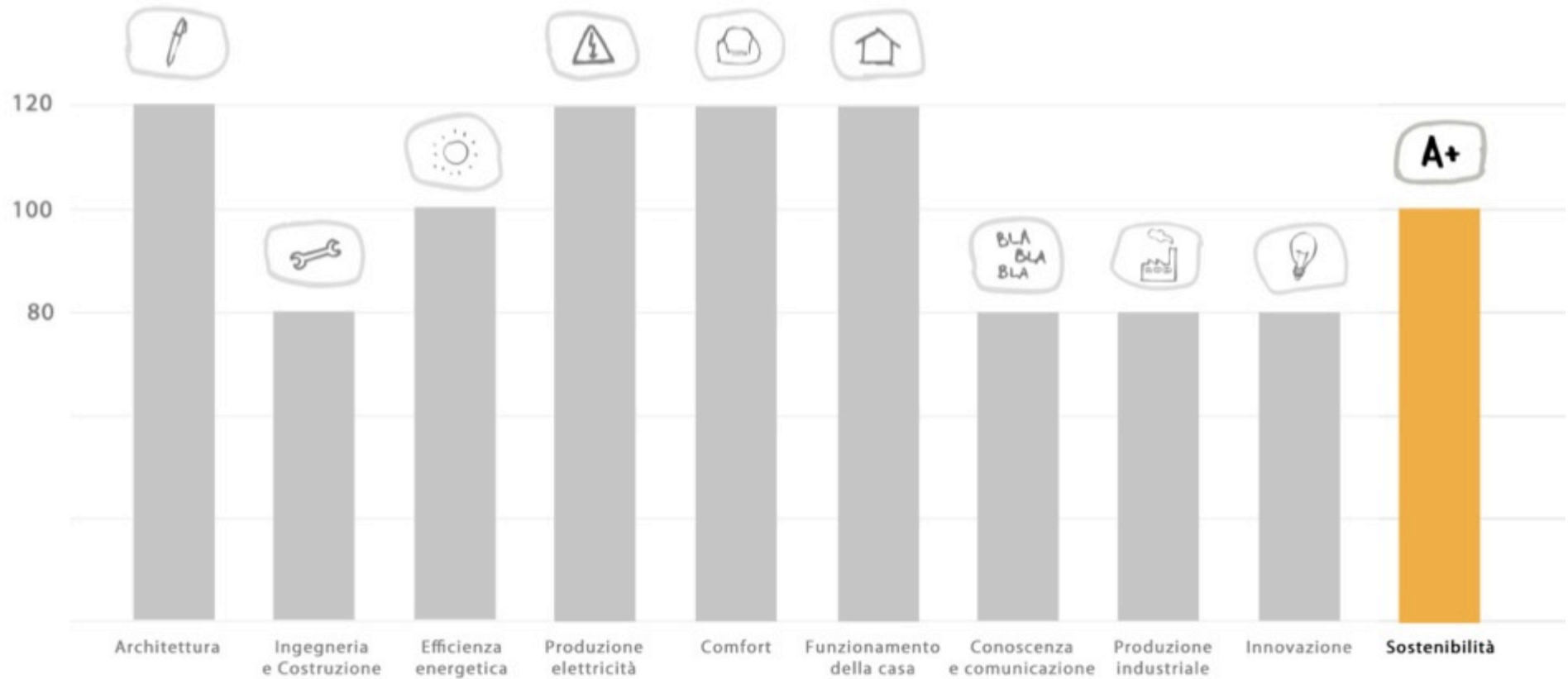

# SOSTENIBILITÀ



## Il team



**Massimo Catalani**

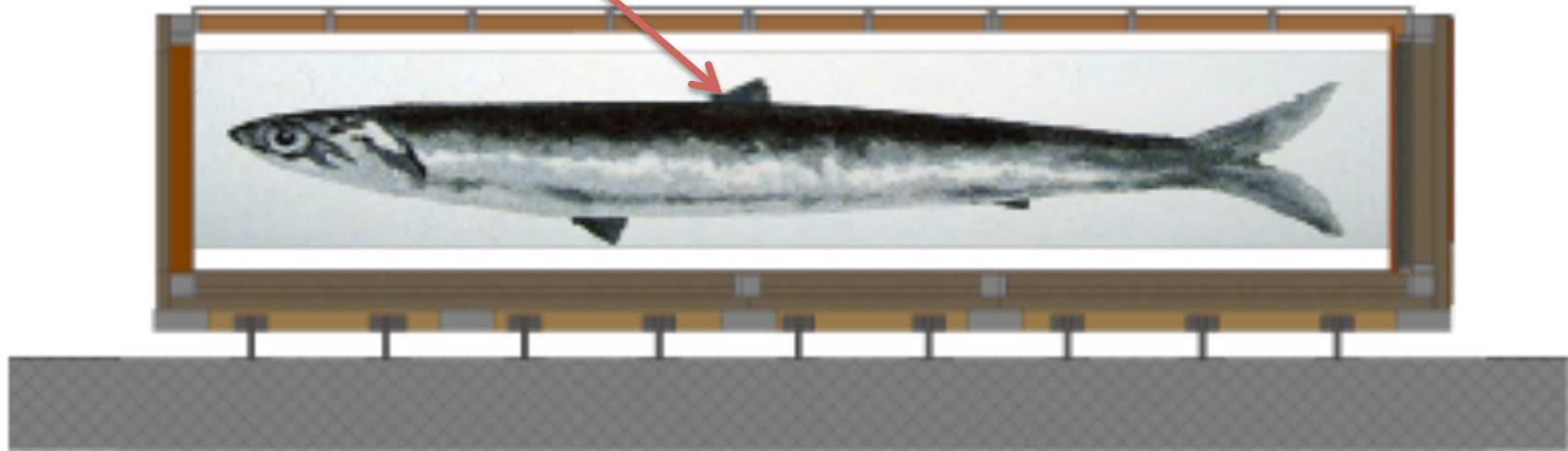



FREIE UNIVERSITÄT BOZEN  
LIBERA UNIVERSITÀ DI BOLZANO  
FREE UNIVERSITY OF BOZEN · BOLZANO



Fakultät für Naturwissenschaften und Technik | Facoltà di Scienze e Tecnologia | Faculty of Science and Technology



## ACCADEMIA DI COSTUME E DI MODA



# MAN WORKING UNIFORM

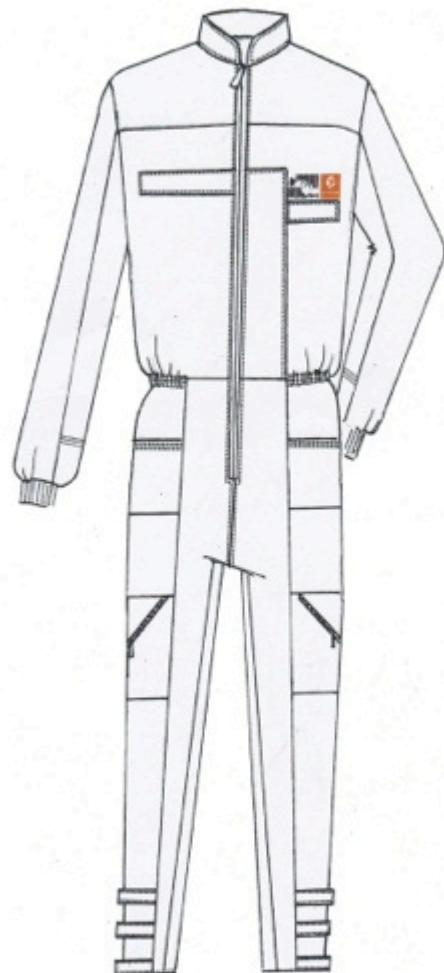

# WOMAN WORKING UNIFORM

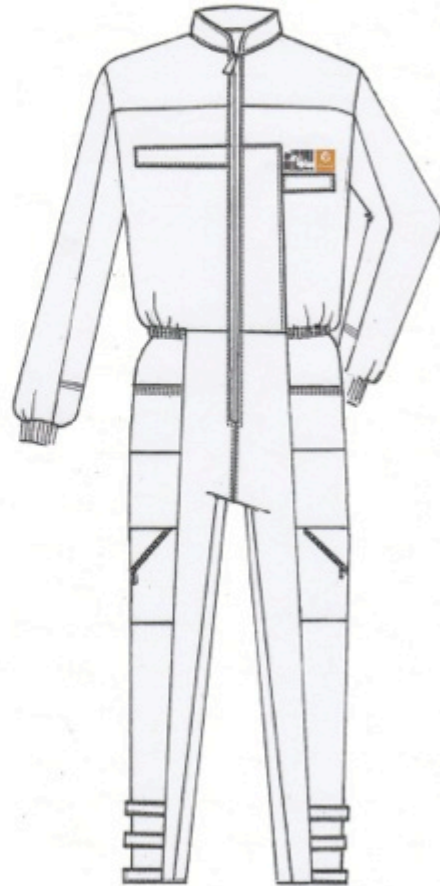



MAN DAY UNIFORM

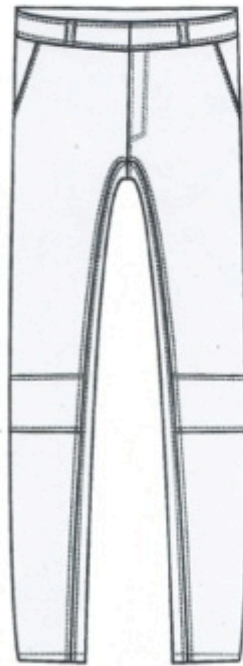

WOMAN DAY UNIFORM

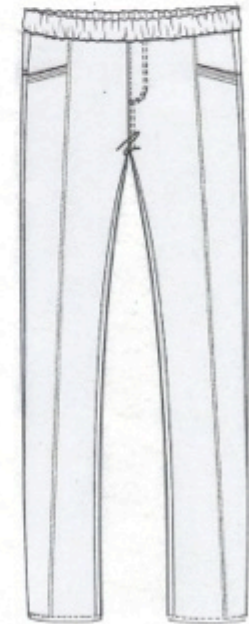
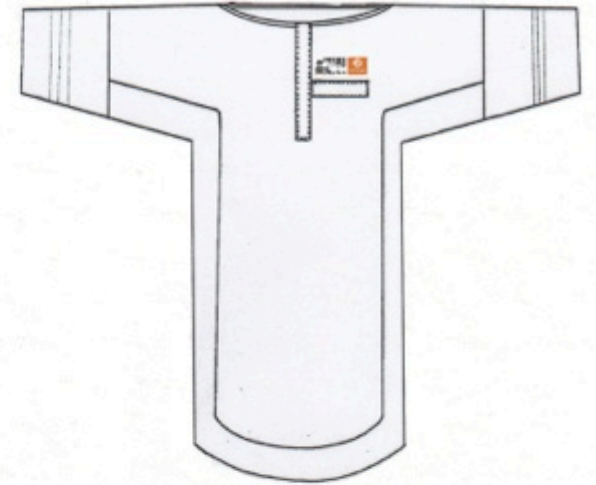

Ci supportano le seguenti **istituzioni**



**MINISTERO DELLE POLITICHE AGRICOLE  
ALIMENTARI E FORESTALI**



... e con il patrocinio di...



Nostri consulenti e **sponsor tecnici** sono le seguenti aziende



e con la consulenza di





## Il progetto



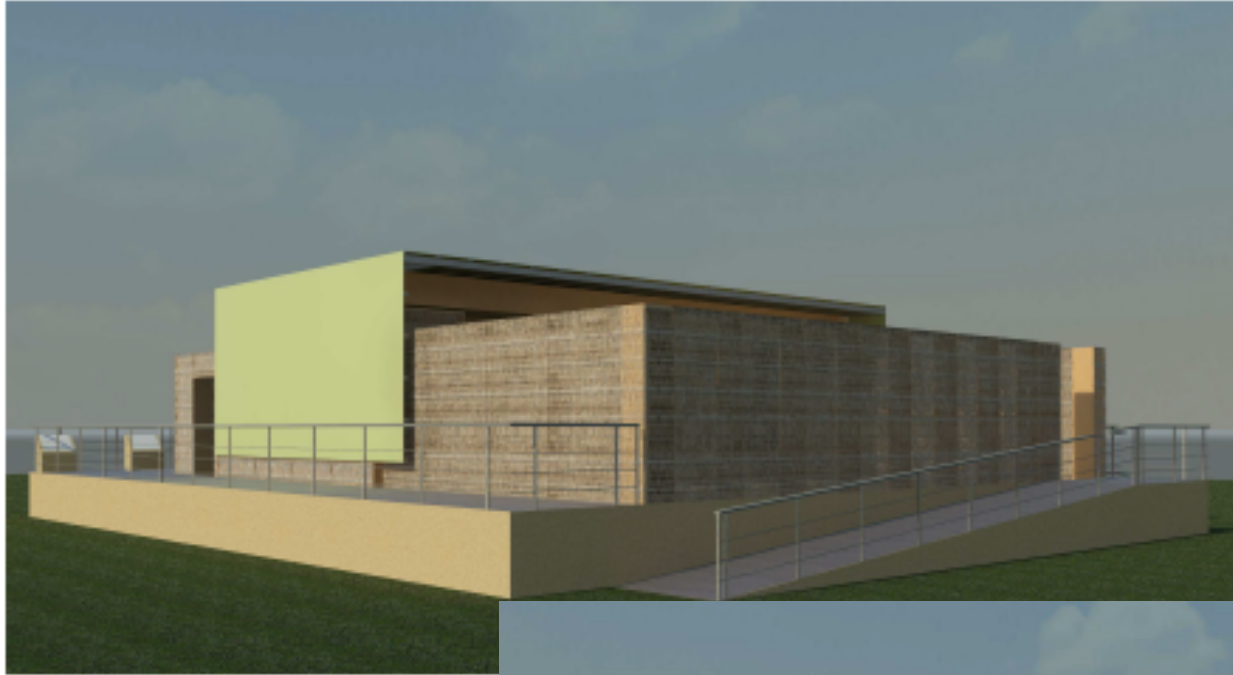

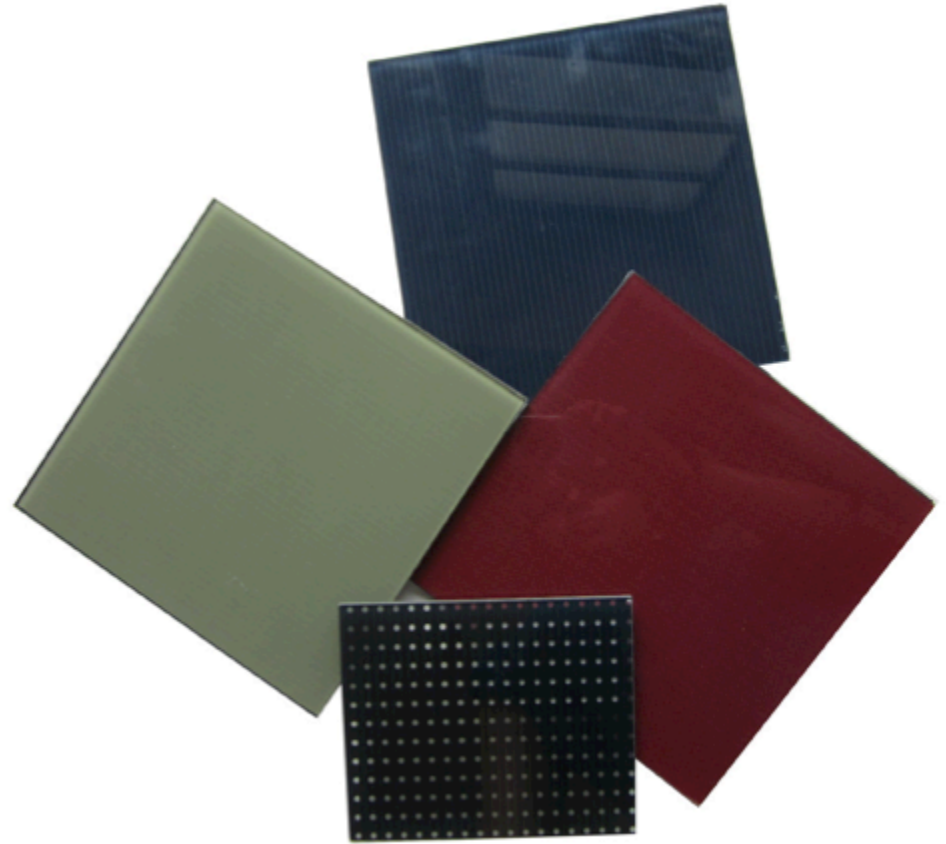

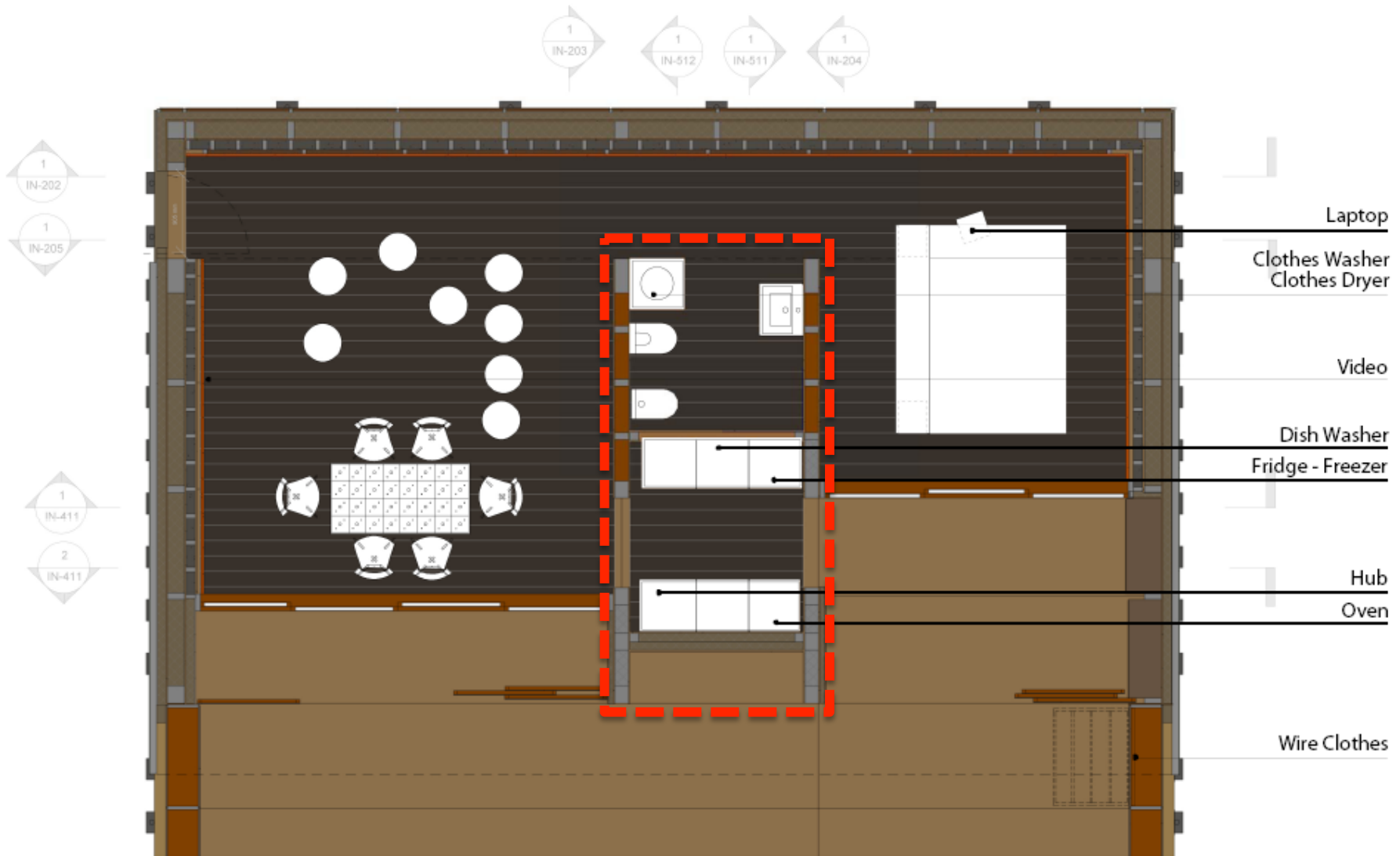

1 Interior Floor Plan  
IN-102  
1 : 50

